

Data sheet

C6_A RJ45 field plug pro 360

Page 1/6

P/N

130E405042-E

EAN 4250184175964

2016-02-02

Illustrations



Dimensional drawing

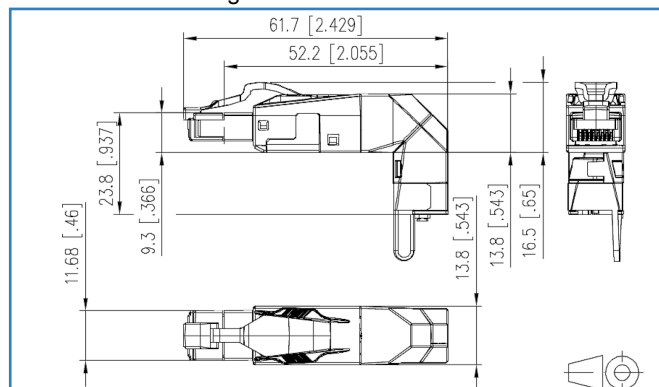

See enlarged drawings at the end of document

Product specification

- Cat.6_A class E_A RJ45 plug to be assembled in the field
- fully shielded and multi-port capable
- variable (360°) cable feed, freely selectable
- easy assembly - connection without special tools
- wire connection: stranded wire AWG 27/7 to 22/7, wire diameter from 0.46 to 0.76 mm
- wire connection: solid wire AWG 26/1 to 22/1, wire diameter from 0.4 to 0.64 mm
- transmission characteristics Cat.6_A per ISO/IEC 11801 Ed.2.2:2011-06
- compliance with class E_A to ISO/IEC 11801
- Ed.2.2:2011-06, DIN EN 50173-1:2011-09
- suitable for 10 GBit Ethernet (IEEE 802.3an), Remote Powering (PoE, PoE plus and UPoE) and HDBaseT
- degree of protection IP20
- for cable jacket from 5.5 to 10.5 mm
- zinc die-cast housing for industrial use
- strain relief by latching clip directly on the stuffer cap
- protected locking hook
- reconnectable

Technical Data

General Data

Fields of application	Structured building cabling, Medical technology
Design	Plugs
Shielding	shielded
Transmission technology	Copper
Color	black
Dimensions	
Dimension (L x W x H)	61.70 x 13.80 x 27.50 mm
Dimension (L x W x H)	2.43 x 0.54 x 1.08 in.
Field assembly ability	yes
Multi-port capability	yes
Labeling option	on housing

Transmission characteristics

Category (ISO)	6 _A
Class (ISO/IEC)	E _A
Category (TIA)	6A
Remote Powering	yes
PoE	IEEE 802.3af
PoE plus	IEEE 802.3at
UPoE	yes
HDBaseT	yes
Transmission rate up to 10 GBit	IEEE 802.3an

Connections/interfaces

Connector technology interface 1	IDC-connection
Connector technology interface 2	RJ45 plug
Number of ports interface 2	1
Number of ports interface 2 equipped	1
Number of positions/contacts interface 1	8
Number of positions/contacts interface 2	8P/8C



Technical Data

Connections/interfaces

Termination data, solid wire (min. - max.)

Conductor cross section, solid wire	AWG 26/1 - 22/1
Conductor cross section, solid wire	0.128 - 0.324 mm ²
Conductor diameter, solid wire (bare copper)	0.409 - 0.643 mm
Conductor diameter, solid wire (bare copper)	0.016 - 0.025 in.

Termination data, stranded wire (min. - max.)

Conductor cross section, stranded wire	AWG 27/7 - 22/7
Conductor cross section, stranded wire	0.111 - 0.355 mm ²
Conductor diameter, stranded wire (bare copper)	0.457 - 0.762 mm
Conductor diameter, stranded wire (bare copper)	0.018 - 0.030 in.

Cable sheath diameter (min. - max.)

Cable sheath diameter	5.50 - 10.50 mm
Cable sheath diameter	0.22 - 0.41 in.

Cable access/outlet	variable, selectable (360°)
---------------------	-----------------------------

Reconnectibility	yes
------------------	-----

Shield connection	flexible contact spring
-------------------	-------------------------

Electrical characteristics

Current carrying capacity	max. 1 A
Rated voltage	max. 50 V
Contact resistance	max. 20 mOhm
Insulation resistance	min. 500 MOhm
Dielectric strength conductor-conductor (secondary)	min. 1000 V DC
Dielectric strength conductor-shield	1500 V DC

Mechanical characteristics

Mounting method	snap-in function
Insertion and withdrawal force	max. 20 N
Life - Number of mating cycles	min. 750
Position/mounting of latch - standard installation position	top
Strain relief	latching clip



Technical Data

Materials and material properties

Material - Housing	GD-Zn (zinc die-cast)
Material - Contact	CuSn (tin bronze)
Material - Contact finish	Ni + Au (nickel-gold)
Material - Latch	Plastics

Environmental conditions

Temperature (min. - max.)	
Temperature - Storage °C	-40 - 70 °C
Temperature - Storage °F	-40 - 158 °F
Temperature - Operating °C	-40 - 70 °C
Temperature - Operating °F	-40 - 158 °F
Particulate ingress	IP2X
Liquid ingress/immersion	IPX0
Electromagnetic measurement	E ₂

Approvals

CE	compliant
RoHS	compliant
UL listed (file no.)	DUXR.E178484

The product meets the following standards

Generic cabling systems	
General requirements	ISO/IEC 11801 Ed.2.2: 2011-06 DIN EN 50173-1: 2011-09 TIA/EIA 568-C
Office buildings	ISO/IEC 11801 Ed.2.2: 2011-06 DIN EN 50173-2: 2011-09 TIA/EIA 568-C
Industrial area	ISO/IEC 24702 DIN EN 50173-3: 2011-09 TIA/EIA 1005
Living units	ISO/IEC 15018 DIN EN 50173-4: 2011-09 TIA/EIA 570-B
Application-specific communications cabling systems	
Profinet	yes
Industrial communication networks - Installation of communication networks in industrial premises	IEC 61918



Technical Data

The product meets the following standards

Connectors for electronic equipment

Free and fixed connectors	DIN EN 60603-7-51:2011-01
---------------------------	---------------------------

Interference proof

Immunity for industrial environments	DIN EN 61000-6-2:2006-03
--------------------------------------	--------------------------

Emission proof

Electromagnetic emission for residential, commercial and light-industrial environments	DIN EN 61000-6-3:2011-09
--	--------------------------

Classifications

ETIM 5.0	EC001121
----------	----------

Packing details

Type of packaging	10 pc(s) / box
Packaging unit - Weight (gram)	413.00 g
Packaging unit - Weight (pound)	0.91 lb
Packaging dimension (W x H x D)	247.00 x 161.00 x 58.00 mm
Packaging dimension (W x H x D)	9.72 x 6.34 x 2.28 in.



Illustrations

Dimensional drawing

